

DMR versus TETRA
systems comparison
Version 1v2

Index

ABSTRACT	3
CONSIDERATIONS ABOUT PROFESSIONAL MOBILE RADIO (PMR) SYSTEMS.....	4
The need of a professional mobile radio system.....	4
Analog to digital PMR	4
TETRA in brief	6
DMR in brief	7
DMR VERSUS TETRA COMPARISON.....	10
Radio frequency aspects.....	10
Coverage	10
Spectrum efficiency	12
Propagation delay tolerance.....	13
“Cell enhancer” tunnel coverage.....	14
Green IT	14
System aspects	14
Features	14
Flexibility and Simplicity	15
Availability	15
Analog migration and coexistence.....	15
Open standard	16
Reliability	16
Costs.....	17
Terminals	17
Base station and node switches	17
New sites and frequency licenses.....	17
Migration cost.....	18
CONCLUSION.....	19

ABSTRACT

People perceive the word “digital” as more advanced and better than “analog” as it presents a number of attractive advantages to the users. Normally this sentence is true, but which technology is the right choice?

This document gives an overview about the most popular digital technologies: TETRA, DMR, P25, dPMR and TETRAPOL. The analysis focuses on the comparison between TETRA and the DMR as the major European digital standards (and among of the most important in the world).

The purpose of this paper is not to provide an exhaustive and detailed technical comparison between these digital standards but rather to provide the key points for deciding correctly which is more suited to your needs. Some technical details may be debatable, and perhaps some could consider them in a different way (any suggestion or correction is encouraged). However, the main concepts explained should give to the reader coherent arguments about the technology that best suits its needs.

In this sense it is important to pay attention to the cost: the coverage area of a TETRA base station is approximately between half and one third compared to that of an analog or DMR radio system, therefore TETRA needs a lot of more sites. A medium size TETRA system may costs 3 to 5 times more than a DMR one. The features of these systems are near the same (digital encryption, positioning, messaging ...) and the younger DMR is developing rapidly the applications not yet available. Then there must be very good reasons to justify the TETRA huge cost increases compared to the DMR.

The alleged spectral efficiency of TETRA has to be considered accurately. In fact TETRA lower RF budget could be cause of the problematic frequency reuse, the poor adjacent channel selectivity and the control channel continuously on air. DMR present a true no-compromises 6.25 KHz/CH solution.

The data transmission in TETRA is often sold as video applications ready. Who reasonably may use a full TETRA carrier to send only one real time video on 22kb/s channel? Probably there are many other ways to perform better with more bandwidth the desired video services with negligible cost (UMTS, GPRS, WiFi, WiMAX ...).

An other aspect to consider is the migration process: from this point of view TETRA is a “revolution” instead the DMR is an “evolution” of the existing analog two-way radio.

TETRA is a trunking system targeted to point to point communications in multi cell and high traffic density environments. Like a telephone network, hundreds of users in a little area require a lot of radio cells to deliver the communications. DMR is a dedicated channel or trunking system targeted to provide robust coverage rather than capacity.

At the end, TETRA may give some advantages over DMR especially for medium to high capacity networks such as big town or large campus. If this is not the case of the reader, it is advisable to request a DMR quoted solution before to choose a digital radio system.

CONSIDERATIONS ABOUT PROFESSIONAL MOBILE RADIO (PMR) SYSTEMS

The need of a professional mobile radio system

Normally the public cellular system (GSM) may not work in emergency because of saturation of the access channels of the cells that leads to slow traffic until to make the communications impossible. A dedicated radio system should ensure communication success even during overload situations.

During an emergency the people involved in it have to communicate in group mode (point to multipoint). This facilitates the operations because everyone knows in real-time the current situation. It is important to perform a very fast group call set-up within 0.5 seconds many times lower than the many seconds (typically 5 to 10s) that are required for a GSM network.

At the end, the coverage area of the public cellular phone network is targeted to cover the maximum population; it is not targeted to cover potentially risk area such as mountain, tunnels and remote locations.

Due the previous reasons the emergency Entities require an affordable, flexible, highly reliable, proprietary radio communications network.

Analog to digital PMR

Different types of mobile communication technologies as analog or digital, conventional or Trunked, and so on have been used in PMR market in the world. The marketplace perceives the word digital as more advanced and better than analog as it presents a number of key advantages to the user, system operators and in the area of spectrum management. Even though analogue FM PMR communications will remain a viable option for several years, digital radio provides relative advantages in:

- ∞ improved voice quality at the fringes of reception;
- ∞ enhanced spectral efficiency (lower frequency license costs per channel);
- ∞ wireless data capability in the same equipment;
- ∞ powerful features like:
 - individual, group and broadcast call;
 - emergency call;
 - digital communications security without degrading voice quality;
 - terminal ID on PTT;
 - late entry;
 - call alert on individual call;
 - polite/impolite channel access;
 - IP based data capability;
 - text messages;
 - automatic position messages;
 - remote radio monitor/ disable/ check;
- ∞ standard multi-vendors solutions;
- ∞ low cost TCP/IP based network backbone.

By contrast, the digital terminals, may suffer by some unpleasant proprieties:

- ∞ at the fringes of coverage area the communication may be on/off without a smooth degradation. In this condition the "analog user" may continue to receive (with some difficulties) a very noisy communication. This situation doesn't involve base stations with diversity reception that dramatically improves the receiver capability.
- ∞ the vocoded audio quality is not as good as an analog one. When the RF field is good, the analog songs as "HI-FI" instead of "sufficient" of the digital one.

Nowadays a public safety communications tends to migrate from analog solutions to digital interoperable standards. Many technologies are available for this purpose:

- ∞ Terrestrial TRunked RAdio (TETRA)
- ∞ Digital Mobile Radio (PMR)
- ∞ Digital Private Mobile Radio (dPMR)
- ∞ Project 25 (P-25 or APCO-25)
- ∞ TETRAPOL
- ∞ ...

The TETRA system, providing 4 channels for each 25KHz spaced carrier, is suitable for trunking systems that should ensure a medium/high volume traffic. TETRA's primary mode uses $\pi/4$ DQPSK modulation that requires a linear or linearized amplifier. The connecting link between the stations require a significant bandwidth to transfer all required signalling (typically in the order of 2Mb/s). The network is of "cellular type" with different frequencies for each repeater and cells size smaller compared with analogue ones. A number of European countries have adopted TETRA for police interoperability.



The DMR standard (ETSI TS 102-361) allows to use a 12.5KHz spaced radio carrier to send two simultaneous radio channels. The spectral efficiency of a single base station is the same as TETRA (1 CH/6.25KHz) but it may be better because simulcast network configuration can be implemented. The modulation, unlike the TETRA, is "constant envelope" type. This property allows to reach lower current consumptions and better efficiency, not having to use linear RF amplifiers it simplifies both terminals and network equipment. The coverage area of a radio station is the same to the one with analogue modulation. These networks are suitable for low/medium traffic networks or for mixed data/voice communications systems (e.g. audio + geographical localization). Finally it should be noted that network and terminals are "dual mode" designed, that is they allow the coexistence of traditional (analogue) and digital devices thus permitting a "soft migration" from analogue to digital system.

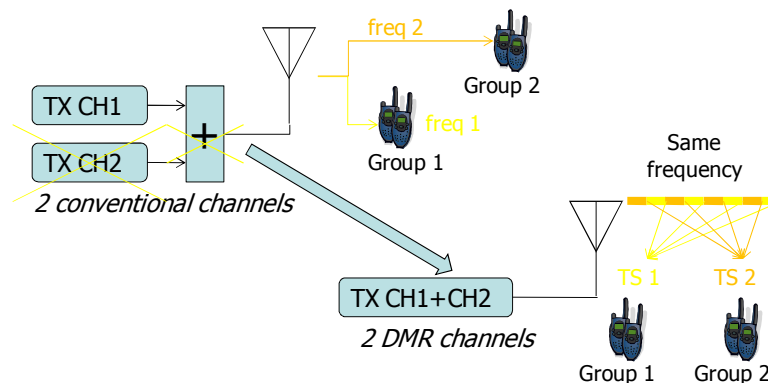

Fig. 1: analog to DMR soft migration.

The dPMR standard offers one communication per 6.25kHz channel bandwidth in Frequency Division Multiple Access (FDMA) technology. This solution may be appropriate in very low traffic environments where 1 channel is enough for the user need. When more than 1 channel is required, it is necessary to implement expensive branching systems with halved RF power.

The compatibility with the adjacent 12.5KHz analog channels is not assured. Due to the modulation contents of the dPMR, some noise may appears in the adjacent channels.

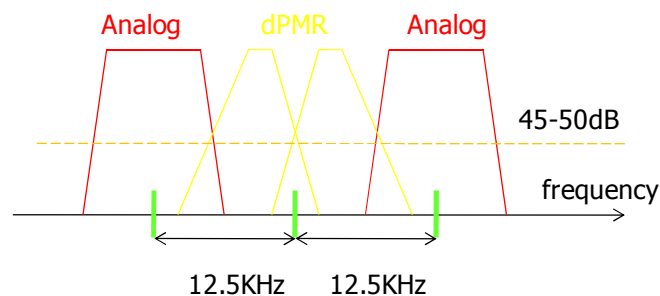

Fig. 2: possible noise between dPMR and adjacent analog channels.

Due to these limitations, this system doesn't appear interesting for the European market in which the channelization has a 12.5kHz main raster and the frequency congestion requires true band optimization.



The APCO25 (Project 25) is a user-defined open standard developed specifically by and for the needs of North American public safety. Radios can communicate in analog mode with legacy radios, and in either digital or analog mode with other P25 radios. The deployment of P25-compliant systems will allow for a high degree of equipment interoperability and compatibility. This system is used principally in North America, Australia, Singapore and Russia.

Phase 1 radio systems operate in 12.5 kHz analog, digital or mixed mode using Continuous 4 level FM (C4FM) modulation at 9.600 b/s. It uses an Improved Multiband Excitation vocoder to encode/decode the analog audio signals at 7.2 kbps (FEC included).

Phase 2 is currently under development with the goal of defining either FDMA and/or TDMA standards to achieve one voice channel or a minimum 4800 bps data channel per 6.25 kHz bandwidth efficiency. The modulation schema CQPSK modulates the phase and simultaneously modulates the carrier amplitude to minimize the width of the emitted spectrum which generates an amplitude modulated waveform. It will require linear power amplifiers in order to pass the amplitude component of the CQPSK signal. The standard specifies also a different and more compressed vocoder to reduce the needed bit rate so that one channel will only require 4800 bits per second.

As network point of view, P25 offers a complete mix of solutions like trunked, conventional, simulcast, etc.

APCO-25 is not much used in Europe, so it will not be described in the following paragraphs.

The TETRAPOL standard was build in France in the '90 and was submitted to ITU-R Working Party 8A. It uses a (GMSK) with a spectral efficiency lower than TETRA or DMR because it allows only one channel in 10kHz of bandwidth. The TETRAPOL channel access is based on Frequency Division Multiple Access (FDMA) with a channel spacing of 12.5 kHz. The gross modulation bit rate is 8 kbit/s using the binary constant-envelope modulation technique Gaussian Minimum Shift Keying (GMSK). Systems are in use in a number of countries in Europe and around the world. EADS is the principal manufacturer of this equipment. This system is proprietary and is the oldest in these digital scenarios, so it will not be described in the following paragraphs.

Other system was specified for digital mobile radio but currently they are not very popular.

TETRA in brief

TETRA is an open standard developed by the European Telecommunications Standards Institute (ETSI Standard EN 300 392). The main purpose of the TETRA standard was to define a series of open interfaces to enable independent manufacturers to develop infrastructure and terminal products that would fully interoperate with each other.

The digital modulation scheme is a $\pi/4$ DQPSK (phase shift keying). The modulation schema is not constant-envelope, so TETRA requires linear amplifiers. If not-linear (or not-linear enough) amplifiers are used, the sidebands re-appear and cause interference on adjacent channels (spectral re-growth). The gross bit rate is 36Kb/s divided in 4 timeslot each carrier (TDMA = "Time Division Multiple Access"). Due to the delay restriction of the TDMA access schema, TETRA is able to operate up to 58 km from a base station.

The speech signals are compressed with an ACELP vocoder, proposed by SGS Thomson, its output is a data stream of 4.567 kbit/s. This data stream is FEC encoded to 7.2 kbit/s that is the capacity of a single traffic slot when used 17/18 frames (1 frame every 18 is used to data and signaling). The net data rate can be varied between 2.4 kbit/s, for high security requirements, using one time slot, and 28.8kBit/s if the data protection protocol is disabled and four time slots are used.

The mobiles may perform both Time Division and Frequency Division Duplex communications.

TETRA system works as a trunking mobile radio network. The main benefit of trunking is normally seen as more radio users per RF channel compared with a conventional radio channel, brought about by the automatic and dynamic assignment of a small number of communication channels shared amongst a relatively large number of users. The fundamental element of a trunking system is a "centralized intelligence" (Trunking Controller) that assigns the radio resource (channel) through one or more control channels. The control channel acts as a signaling communications link between the Trunking Controller and all mobile radio terminals operating on the system. The control channel is always

on air in absence of traffic also. The base stations normally transmit continuously and all slots should be filled with an idle burst.

The hand-over process, due to the trunking nature of TETRA, requires good RF field with large overlap areas to perform efficiently. The backbone network of a TETRA system should allocate bandwidth enough to fast transportation of digital audio and signaling and it should be equipped by fast switch nodes.

The TETRA standard will evolve to the Release 2 that will provide additional enhancements as:

- range extended up to 83 km
- more compressed codec
- many choices of modulation and RF bandwidth
- data transmission up to 500 kbits/s on 150KHz bandwidth

DMR in brief

DMR standard (ETSI TS 102 361 technical specification) is an open standard, defined in ETSI world by a working group made of main PMR equipment producers of the world. The DMR standard building followed guide lines of PMR market requirements for digital flexible systems, able to give added value to the present analogical systems, but at the same time to guarantee a gradual migration between the two technologies, making investments and specific operative existing requirements safe.

To this aim Radio Activity DMR repeaters are designed with the double standard technology, they are able to work both in analogical and digital way, then supporting both classic PMR terminals and the new DMR ones, with every operating characteristic of each technology (“dual mode”):

- ∞ voice communications with FM analogical modulation and selective calling based on traditional protocols;
- ∞ voice communications and data transmission with 4FSK digital modulation, according to the DMR standard, with 9600 bps gross total speed.

Furthermore the selection of required working mode is fully automatic, this means that the repeater is able to autonomously detect if the incoming communication is analogical or digital and can consequently configures itself to work as a PMR or DMR respectively.

DMR standard performs the transportation of both data and voice. Audio signal is converted into digital format, compressed, “packed” into digital transportation channel, differently “marked” than the data digital signal.

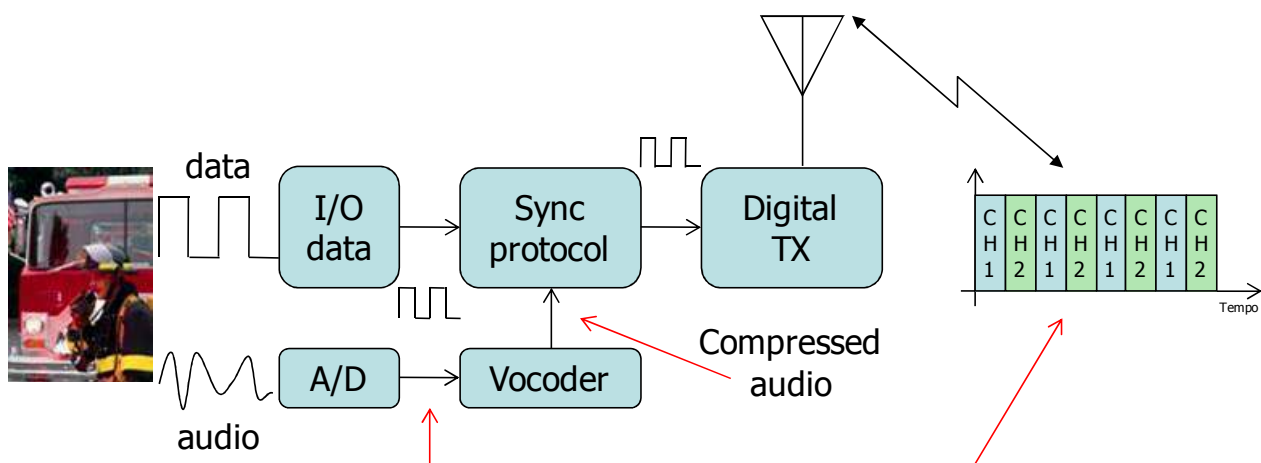

Fig. 3: DMR transport and processing of audio and data signals.

Audio/data channels are managed with two TDMA (Time Division Multiple Access) timeslots sharing the same radio 12.5 KHz wide channel. The two audio/data channels are perfectly separated and independent from each other, as if they worked in a conventional mode on different frequencies (carriers). The transmitter becomes active only during timeslots belonging to their working channel.

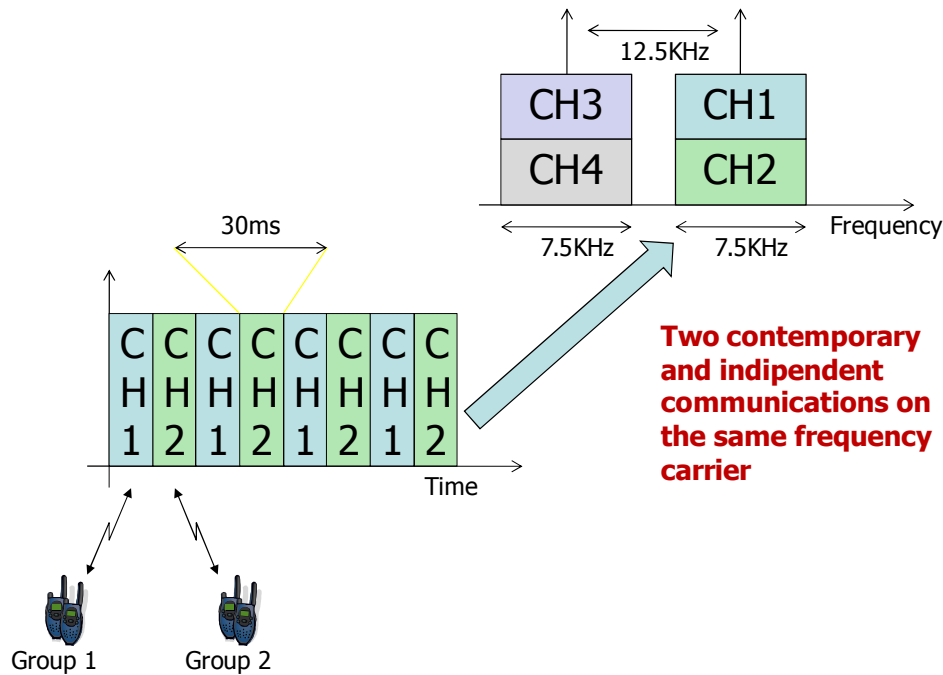

Fig. 4: audio/data channels and TDMA timeslots.

DMR systems can live together with conventional analogical systems on adjacent channels without any performance degradation for both. DMR system has a spectral efficiency of 1CH/6.25KHz, the same as TETRA and double in comparison with conventional systems. Only one radio head (only one transmitter) gives 2 CH without the need of RF coupling systems, with the effect of lower costs and consumptions and greater available power. Furthermore, DMR system allows the direct communications between terminals. In this case only one channel per 12.5KHz will be available because the synchronization is made by repeater/network.

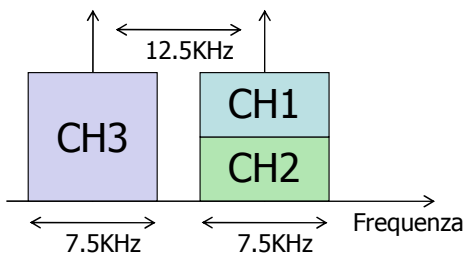

Fig.5: Analog and DMR coexistence.

The implemented modulation is 4FSK type (Four-level Shift Keying), optimal for use with PMR communications. Information bits are transmitted by couples, each couple is assigned to a frequency shift.

The modulation is constant envelope frequency type. This implies great advantages in terms of energy consumption: transmitters are very similar to their classic analogical version, expensive linearization is not required, and they can work in saturation mode (C class or superior) with energy saving and consumption compatible with solar panels systems.

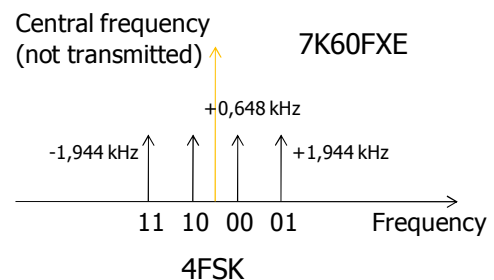

Fig. 6: DMR modulation type.

The modulator must have a flat frequency response between 0 and 5 KHz. Transmitted RF power level by a DMR systems is the same as the one of a traditional analogical system (constant envelop). The sensitivity of a DMR receiver is about the same as the one of a traditional analogical system, but the audio quality remain constant up to the sensitivity limit and the coverage is slightly bigger than 12.5 KHz analogical systems.

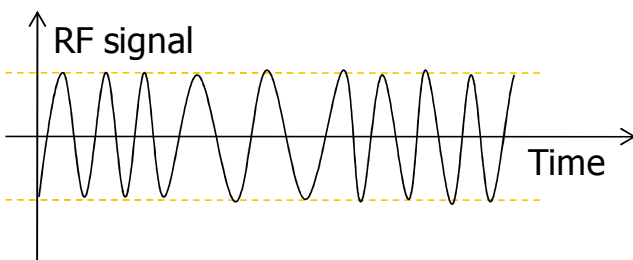

Fig. 7: Frequency modulation constant envelope type.

DMR terminals can work in "open channel" mode like traditional systems for emergencies, but individual calls and group calls are available: obviously selective callings are addressed in a digital format between DMR equipments. Network access of DMR terminals is regulated by a "colour code" which replaces sub-tone sub-audio tone.

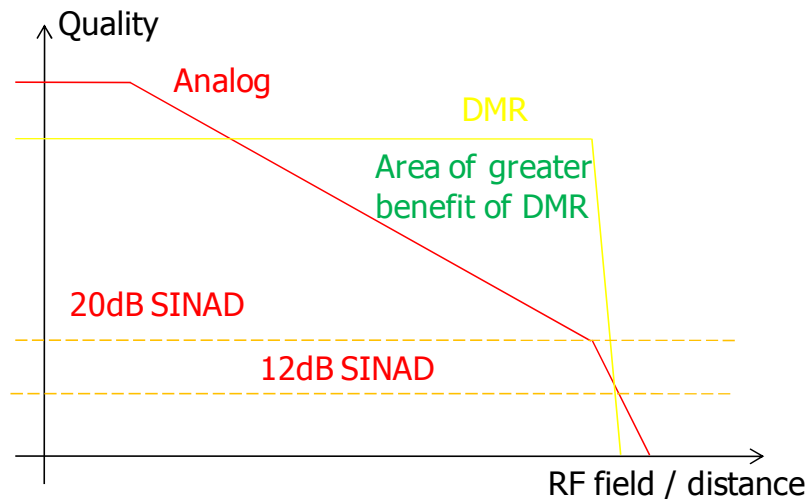
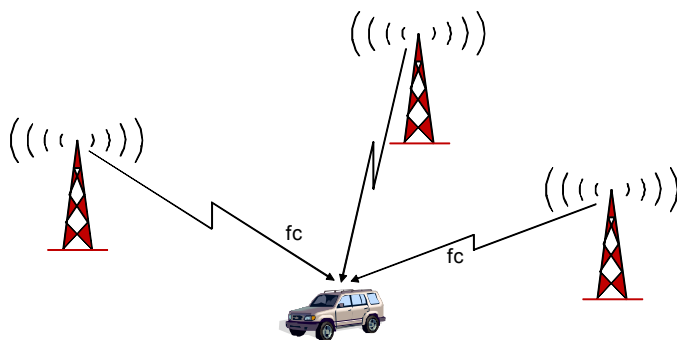

Fig. 8: evolution of quality in relation to the RF field/distance both for Analog and DMR.

The DMR performs the **simulcast technology** also. A simulcast network is a very powerful radio network in which all the repeaters are active on the same frequency and at the same time.



Main advantages:

- ∞ Automatic and continuous roaming and hand-over => Easy to use
- ∞ Functioning like single "big repeater" => automatic and simple conference call operation
- ∞ All stations directly connected to the network => Integrated communication sys
- ∞ The same RF channel over all Network => no change of channel in the coverage area, one communication per channel

Every channel of the system is independent from the other channel. The communications in one channel can be transfer to another channel by a junction at master/Central Office level or by adding a trunking controller in the master station.

The area of coverage of every single simulcast channel could be expand easily by adding some simulcast base stations. These simulcast base stations will be integrated in the network with few operations at network level only (nothing is request on mobile terminals).

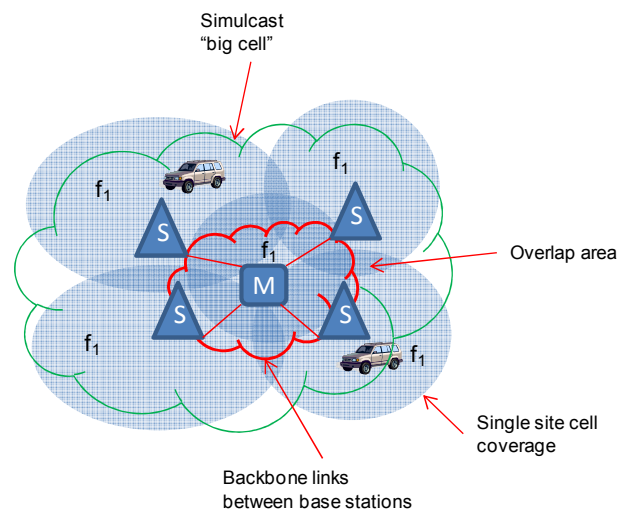
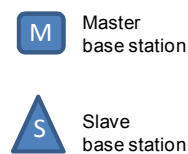

The simulcast network removes the need of scan on mobiles and portables, assures real time roaming and hand over during the call and reduces frequency license costs.

⇒ Note that in the following paragraphs we will usually consider a TETRA system compared with a DMR simulcast system to confront the systems with near the same features.

DMR VERSUS TETRA COMPARISON

Radio frequency aspects

Coverage

The coverage area depends on many factors. Fixed the RF power (E.R.P.) of the devices, the noise figure of the receiver and the orography of the region, the coverage area depend mainly from RX sensitivity and frequency band.

The RX sensitivity is related to the bit rate and bandwidth of the transmission. Normally higher data rate at fixed

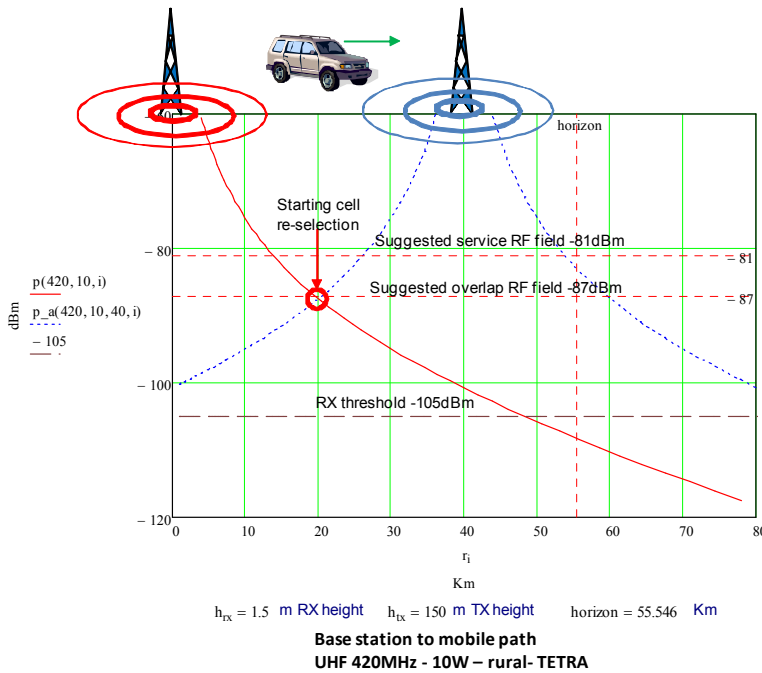

bandwidth tends to reduce RX performance due to major sensitivity to noise (e.g. multilevel) and due to the increase of noise bandwidth (and its relative power also). The result is that the typical dynamic receiver performance is about -110dBm for DMR terminals and -105dBm for TETRA.

TETRA is a trunking system with the control channel continuously on air. The mobile selects the better cell when the field currently received from a base station drops under a certain threshold. This threshold may vary due to many factors like the degree of service needed, the type of terrain, the expected mobile velocity, etc. A typical value for this threshold in rural terrain is 18dB over the dynamic RX sensitivity (typ. -87dBm). The coverage design of an area should ensure this value everywhere. The simple simulation on figures 9 and 10 explains the concept better.

Fig. 9: TETRA Base Station to mobile path UHF 420MHz – 10W –rural.

The coverage of a TETRA cell in a system may be taken in about 20Km, many times less of the optical horizon and of the dynamic RX sensitivity.

DMR has the possibility to perform simulcast network. A simulcast network is a radio network in which all the repeaters are active on the same frequency and at the same time. The simulcast network removes the need of scan on mobiles and portables, assures real time roaming and hand over during the call.

The mobile doesn't search the best cell because is the system itself that keeps (by the voting system) and reaches (by the simulcast transmission) the mobile. In case of simulcast the service field may be few dB over the dynamic RX sensitivity. The result is about 40Km of radius.

⇒ The simulcast DMR, in the same RF band, may double the cell radius respect to TETRA!

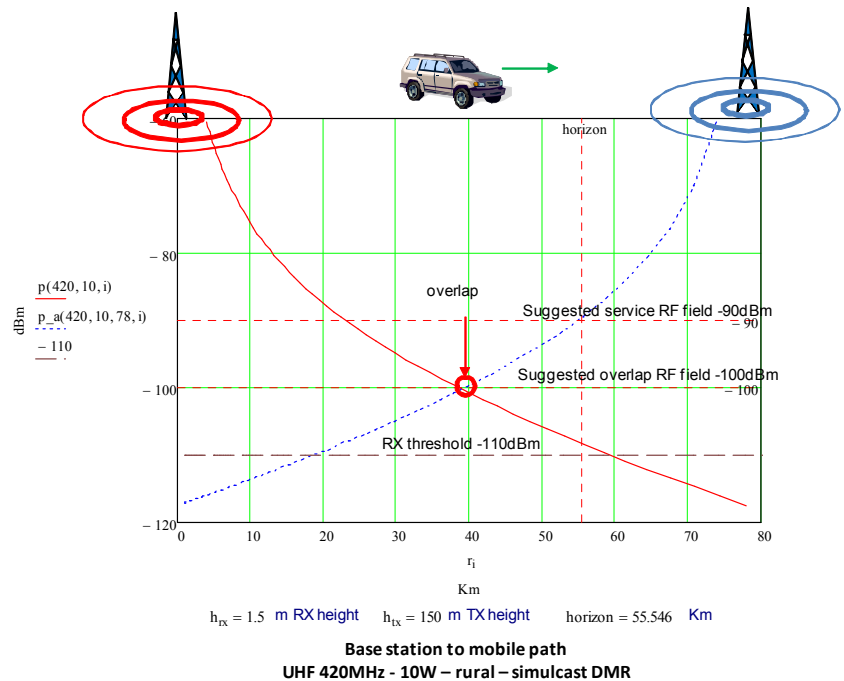

Fig. 10: DMR Base Station to mobile path UHF 420MHz – 10W –rural.

The coverage depends on RF band also due to propagation effects. TETRA systems are in the ranges 380 to 400 MHz for public safety and security networks, and 410 to 430 MHz for private radio networks, each with 10 MHz duplex spacing. Recently some TETRA applications are available in 806-870 MHz band also. A user that has got an analog system in VHF band may have to implement several sites (and several new frequencies) more to use TETRA.

The simulations on figures explains the situation of the up-link and direct mode link in an extreme (not uncommon) case of existing VHF band changing to UHF for TETRA.

In TETRA the required linearization of the RF power amplifier on terminal equipments implies that the RF power may be lower than non linearized ones. Typically a DMR portable gives up to 5W compared with the 1W (typical) of the TETRA one (more than 6dB less!).

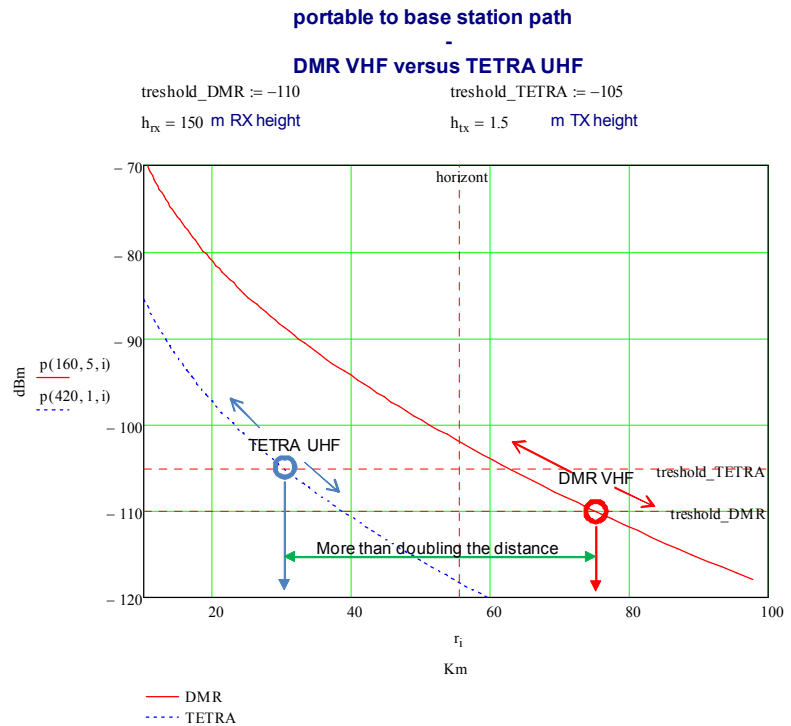

Fig. 11: portable to base station path - DMR VHF versus TETRA UHF.

The overall RF budget link (in the same RF band) of DMR reaches about +5dB more RX sensitivity and +6/7dB more RF power respect to TETRA one. These 10-12 dB and the unavailability of VHF TETRA may reduce the coverage radius to about ½ respects to DMR. In terms of coverage area (proportional to the square of the radius) it produces a theoretically 4 times more sites for TETRA system respect to the existing (analog) sites.

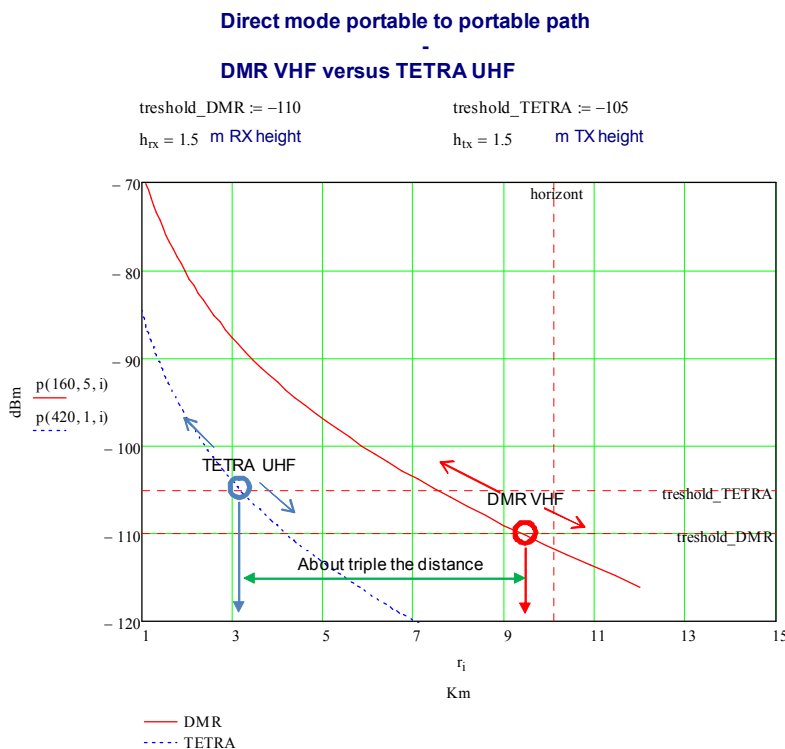

Fig. 12: Direct mode portable to portable path - DMR VHF versus TETRA UHF.

⇒ At the end, due to TETRA lower RX sensitivity, lower available RF power, UHF band availability only and no simulcast schema allowed, in most practical cases the system planner must double the (existing) sites to achieve the same coverage of a DMR system.

At the opposite, DMR exists in all conventional mobile radio bands, it has a constant amplitude modulation and it allows use of nonlinear power amplifiers. Use of nonlinear amplifiers produces RF power levels that are equals to the current analog equipments. The sensitivity of RX's DMR is near the same of the analog, this means that digital systems can be implemented with little or no loss of coverage respect to the previous.

Note that the lower RF budget link of TETRA may suffer significant loss in direct mode operation (about 3Km for TETRA UHF, more than 9Km for DMR VHF) also respect to the DMR.

Spectrum efficiency

RF spectrum efficiency is a combination of some main factors as the bandwidth per communication channel, the frequency re-use factor determined by the Carrier to Interference protection ratio C/I in dB's, the cell dimension and the access technology used. The DMR RF access schema is explained in the figure below.

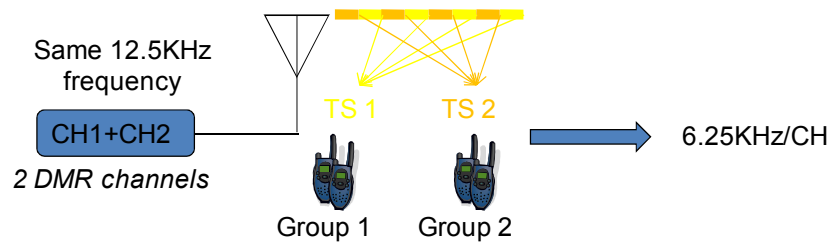

Fig. 13: DMR RF access schema.

Two user group can communicate independently over the (really) 2 user channels available. The corresponding TETRA schema is:

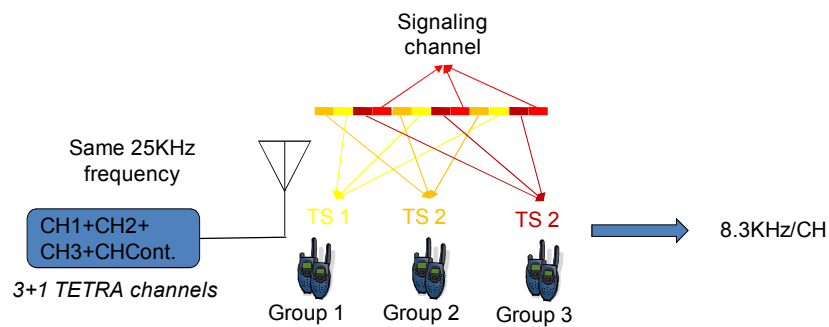
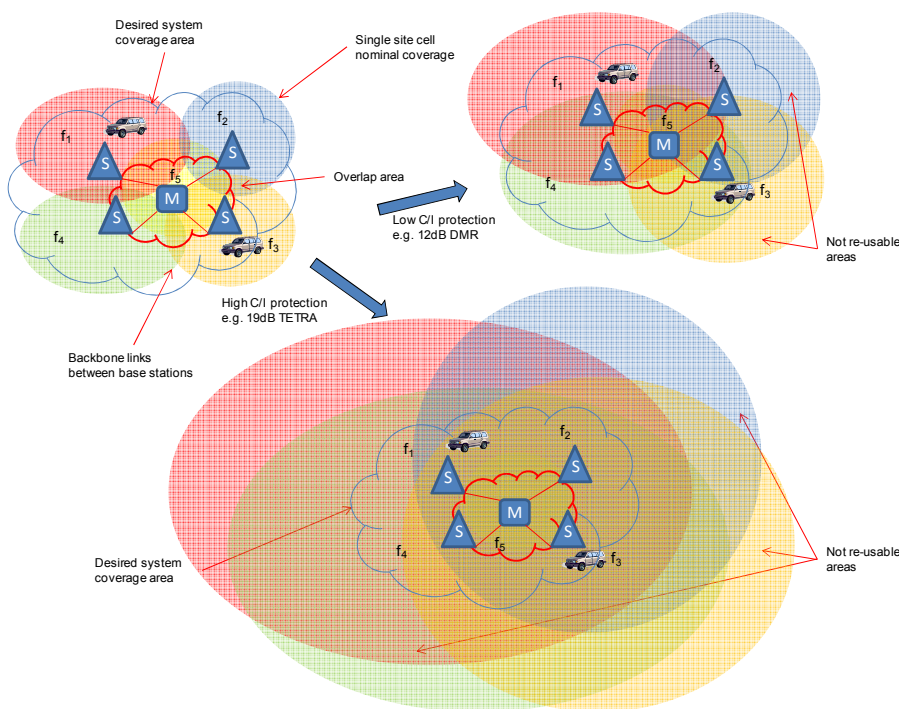

Fig. 14: TETRA RF access schema.

DMR has higher spectrum efficiency. A TETRA base station offers 4 timeslots in 25 KHz of bandwidth. One timeslot is dedicated to trunking signaling, so the remaining 3 timeslots perform 3 contemporary communication channels. In DMR the 2 timeslot available from a base station require 12.5 KHz bandwidth but no timeslot is required for protocol. \Rightarrow DMR spectral efficiency is $4CH/25\text{ KHz}$, the TETRA one is $3CH/25\text{ KHz}$ only.



The reference carrier to interference (C/I) ratio in TETRA system is 19 dB where DMR (similar to analog) perform a 12dB only. It means that a TETRA frequency couldn't be used until the RF field emitted from a base station goes down more than 19dB under RX threshold. In terms of distance, the 7 dB worst figure of TETRA may be translated in a lot of km of not re-usable frequency area (consider that the RF field may attenuate very slowly [6-9dB/doubling the distance] at the edges of coverage area). Careful frequency planning helps to minimize this issue, but often it cannot fully solve interference problems.

Fig. 15: DMR – TETRA comparison of the reference carrier to interference (C/I) ratio.

Note also that, in case of simulcast (DMR only) the grade of frequency reuse will be the best due to the single frequency use and the major possibility to “customize” the coverage area to the needs of the user.

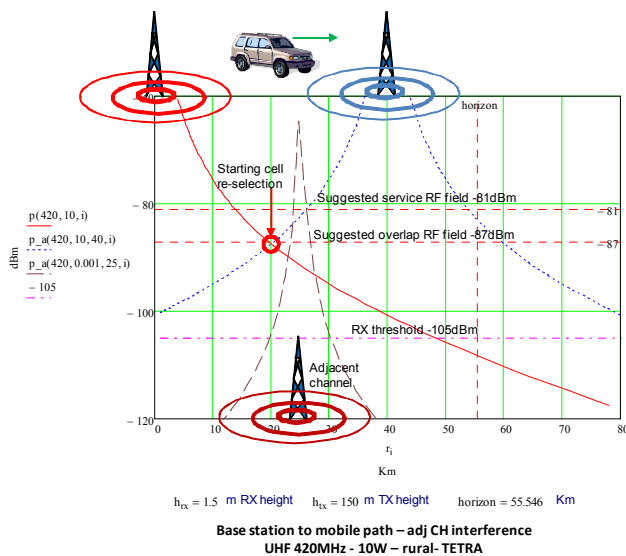

Fig. 16: TETRA Base Station to mobile path – adj CH interference UHF 420MHz – 10W –rural.

This 25Km of distance appears the minimum requirement for TETRA frequency system planning. In PMR the frequencies in a certain area are often co-coordinated by the regulator entity without a detailed attention respect to the adjacent frequency allocations. A TETRA network working initially well, may suffer many degradations when another adjacent TETRA network is implemented without precautions.

At the end, note that TETRA system has a 3+1 (minimum) channels starting point in 25KHz bandwidth. A lot of users have got a single 12.5KHz channel, operate in open channel and don’t need more traffic. With a DMR system, without changing frequency, they could operate as previous with a lot of other “digital” features like GPS positioning, audio encryption, efficient messaging, remote control...

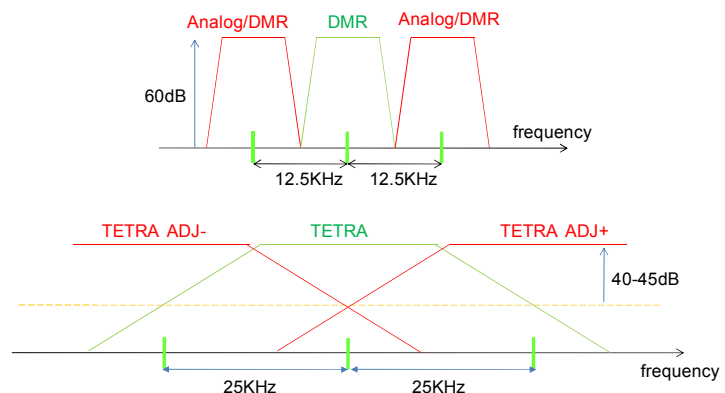

Fig. 17: DMR – TETRA comparison of the adjacent frequency allocation.

⇒ In the PMR system the frequency allocation is often regulated without consider the adjacent channel effects. The result may be a degradation of performance in the presence of other adjacent systems.

Propagation delay tolerance

The coverage radius of both the systems has a limitation due to the TDMA access schema. The mobile equipment must synchronize accurately to the base station timing to avoid overlap of the TDMA slots.

DMR uses 2,5ms between adjacent timeslots for guard time to allow for PA ramping and propagation delay. A 1 ms propagation delay allowance is built in to the Normal Burst structure for propagation delay and time base clock drift. This 1 ms allowance, theoretically, enables a mobile to operate up to 150 km from the BS without inter-slot interference. In TETRA the guard time is about 0,4 ms, which gives 58Km maximum cell radius only. This limitation may be unacceptable into the systems which have airborne Mobile Stations that may receive a good signal at ranges much greater than the 58km limit.

“Cell enhancer” tunnel coverage

The more robust way to cover a tunnel is to use some base stations connected directly to the external system. This solution allows a better failure resistant figure, it can serve internal communications when the external network is not accessible or it is not operative.

However it is not uncommon to extend coverage in tunnels without the possibilities of a direct backbone connection to the external network. In these cases the system integrator may use “cell enhancer” devices. The external signal is kept by an antenna, it is amplified up to reach the requested power and it is sent into the radiant cable.

Fiber optics devices are often used to transport the RF signals into the long tunnels. In these cases it is mandatory to control the delay difference between the amplifiers. The delay produces an inter-symbol interference on the mobile terminal that may be destructive. The delay tolerance has to keep less than a eighth of the symbol rate. The TETRA application is more critical respect to DMR due to the higher symbol rate. In practice TETRA require 7-10 microseconds of maximum delay spread instead of 30-40 microseconds of DMR.

Green IT



DMR allows higher power supply efficiency respect to TETRA. Due to the linearization requirement of a TETRA transmitter and the continuous activity of the control channel, a TETRA base station requires 8 to 15 times the mean power than that required by the DMR. The power absorption of TETRA base station requires also cooling and conditioning system adding other power consumption. DMR base station, like an analog one, is solar panel ready.

The TETRA base station (including cooling systems and switches) may require 10-15kWh/day in respect to the 0.8-1.2kWh/day required by a DMR one. For a medium size network of 1 carrier and 5 sites, the TETRA infrastructure power requirement produces in a year about 12tons of equivalent CO₂ emission in respect to 1tons only of the DMR!



Lowering the power requirements produces also a longer operation and life time in battery powered devices (portables).

⇒ *A medium size TETRA system (5 sites with 1 carrier) may require about 1.000 threes to absorb the equivalent CO₂ generated by the overall power supply requirement!*

System aspects

Features

Both the systems perform the same enhanced digital basic features like individual/group/broadcast and emergency call, automatic position messages, late entry, terminal ID on PTT, IP based data capability, etc...

Nowadays the TETRA equipments on the market offer a more powerful encryption and allow duplex communications over terminals in time division duplex. TETRA applications, due to the maturity of the standard, are more than DMR ones.

The DMR encryption is not ETSI standardized yet, but it is a choice of the manufacturer. Motorola MOTOTRBO™ terminals perform two level of encryption, one is “basic” with low security (255 non dynamic keys) and the other uses an “advanced” algorithm that assures a higher level of security.

The DMR time division duplex is specified by ETSI but there isn't a terminal in the market that performs it.

The ETSI protocol is very open; a myriad of applications may be easily implemented on it. Due to the relatively recent (2005-07) standard definition by ETSI compared with TETRA (1990-95), it is presumable that DMR will dramatically increase its features and applications in the near next future.

Flexibility and Simplicity

TETRA is a “revolution” in the radio system approach. TETRA is a trunking system; it is able to cover from 1 site to a region with thousands of users. It seems a cellular phone system like GSM rather than a popular conventional radio system. It requires powerful switching node and broadband transportation backbone, accurate coverage design and frequency planning: it is complex and not easy to manage and to understand by the user! Complexity involves often a system administration entity that ensures continuously the correct functioning of all system (terminals also). TETRA doesn't perform some popular and effective solutions like simulcast or simple interconnected repeaters. TETRA must be used as it is.



DMR is targeted to a simple and smooth migration of the existing analog two-way radio systems to the digital era. The DMR standard allows a lot of network configurations started from a single repeater to several connected base stations. With DMR it is possible to realize the same structures used in most of existing two-way radio systems: interconnected repeaters, multicast (IP/wired connected), simulcast (IP/UHF/wired connected) and some multi-access and trunking systems. The system design approach is very similar to the analog conventional one. A new coverage design is not required due the re-use of existing customer frequencies, jointly with the same coverage performance.



Tanks to the IP main backbone, DMR presents an easy and a low cost upgradability of a network. Not specific (and expensive) switching nodes are requested. The insertion of a new base station to increase coverage area is easy and fast, saving customer investments and additional cost for the set-up operations. The resulting system is simple, nearly a collection of stable, affordable, highly reliable, “stand alone” repeaters.

DMR is a flexible “plug and play”, easy to understand solution.

Availability

Nowadays the TETRA standard is very popular in the world except in North America because of the policies of the major suppliers. DMR systems are at an early stage, but they are already installed worldwide.

In North America the choice for a radio system is essentially limited to analog two way radio or to the expensive P25 digital. DMR may introduce a new era for the two way radio in which digital performances will be available at the cost of analog equipments.

Analog migration and coexistence

Organizations that have successfully used analog radio for years have a lot of care to an abrupt change of their systems. The radio services unavailability and the appearance of new unknown problems during migration may discourage the potential customers.

DMR should be a natural migration path from analogue radio systems to digital ones. Using the same modulation schema (constant envelop, FM, 12,5KHz bandwidth) than analog, the DMR equipment can easily perform a dual mode analog/digital communication.

A customer can start to implement the DMR radio infrastructure over the existing analog and can immediately switch to the new infrastructure making it work in analog. No appreciable difference would appear using the old analog terminal in the new DMR (dual mode) infrastructure. If there is any problem, it is easy to switch back to previous system to solve it without significant radio services interruption. Note that the customer, due to his experience, may solve easily problems in analog, and instead could have more difficulty in the digital.

Once analog operations are tested, the customer may start gradually to implement the new DMR equipments working in dual mode and interoperating with the (old) analog. DMR migration assures immediate enhancement of operations also in a mixed analog and digital terminals population.





TETRA migration presents very different scenarios. TETRA offers very low possibilities of interoperability from digital to analog terminals and often requires new sites to cover the same area of the existing (analog) system. Migration from analog to TETRA is a revolution in the radio approach for infrastructure aspects and for the end user also. Tuning the new digital system may require a lot of time to solve unknown problems in an unfamiliar environment. The migration from analog to TETRA may produce a sensible discontinuity and requires a “one shot” big investment to change all the radio equipments in the same time.

Note that the preferred approach to migration will be to locate the digital new system on the existing frequency assignments wherever possible or within the allocated land mobile service bands. DMR exists in the most used land mobile bands, TETRA frequency ranges in UHF only.

Open standard

TETRA has a mature multi-vendors environment. The major manufacturers have standardized and inter-operable radio platforms so it is easy for a customer to select the best supplier.

DMR is too young to fit the same environment. Nowadays (July 2009) only Motorola MOTOTRBO™ terminals and SELEX V/5x-PDMR data box are available for DMR. Many companies have announced the interest in DMR technology and some of them are developing terminal equipments (Tait, Hit, and Simoco).

ETSI has started to specify the inter-operation requirements; however some focal points must be specified to set DMR as open standard effectively:

- ETSI does not specify the vocoder and the related signaling
- the text messages protocol and most services like positioning are not specified by ETSI
- no inter-operability tests are specified by ETSI

The vocoder implemented in Motorola MOTOTRBO™ terminals is the AMBE II+™ (Advanced Multi-Band Excitation) that is a proprietary speech coding standard developed by Digital Voice Systems. The use of the AMBE standard requires a license from Digital Voice Systems so it seems a hard restriction for the open standard purpose. Actually this fact is not a really closure because the same (or very similar) vocoder is used by dPMR, ICOM amateur radio and it is the most probable selection for P25-Phase2 and TETRA phase 2.

Motorola first started to develop so making it a “de facto” standard. Probably the next actors should follow the Motorola’s protocols and vocoder because it is already in use. By the other hand Motorola is interested to create an open standard due to the commercial powerful of a multi-vendors environment.

Note that the base station for network applications doesn’t suffer significantly by this un-defined standardization because it performs the transportation layer only that is fully specified by ETSI.

Reliability

The complexity is normally the first index of potential failure in a system. Well known MTBF calculation predicts that the expected failures rate has a strong correlation to the number of components and to the temperature of working. Both these indexes are worst in TETRA infrastructure respect to the DMR system approach (at the same level of manufacturer quality of the equipments).

TETRA and DMR networks typically provide a number of fall-back modes such as the ability for a base station to process local calls. DMR may present some advantages compared to TETRA for the intrinsic “stand alone” and distributed intelligence of the base stations and their lower or null dependence from centralized switching nodes. At the end, it is important to note that the DMR simulcast approach (not available in TETRA) represents a very high reliability system solution due to the intrinsic redundancy of the base stations.

Due to the low power requirement and the low size of DMR base station, it is easy to prepare a rapid transportable, fast setup, network solutions for disaster relief and temporary capacity provision. It is not so easy with TETRA.

Costs

A customer who needs to change the old analog radio system, in most cases looks at a digital solution. The investment cost of a new system requires doing some considerations about the best features/cost ratio. Features of DMR and TETRA are about the same or, for DMR, they will be soon. The comparison involves, as main point, the total cost of the system.

Terminals

The TETRA terminals, due to the power amplifier linearization, should be more expensive than those for the DMR. But the greater spread of TETRA terminals (more than 10 years on the market over 2 years to DMR) and the multi-vendor environment instead allow a terminal cost almost the same. Motorola has pledged to work with dealers to hold the line, keeping the prices for MOTOTRBO DMR handsets close to what the customers currently are paying for analog devices, to encourage them to make the migration.

Probably, when new actors will present their DMR products, the price of DMR terminal may go down to the TETRA level.

Base station and node switches

Nowadays Motorola proposes a DMR repeater at very low price, comparable with an analog one. Note that a DMR repeater performs 2 full-duplex channels so the cost per channel may be competitive with the analog with the performance of the digital one. The single base station TETRA costs more than 10 times the DMR repeater.

A more reliable infrastructure may require some sites to cover an area. In case of DMR there are many solutions available at different level of price: simple repeaters interconnected, multi-frequencies (multicast), simulcast, trunking (nowadays the simple Capacity+™ from Motorola). TETRA offers the trunking solution only. The indicative cost of the base stations only, for both DMR and TETRA and depending on the type of configuration, is shown in the table below where N is the number of sites (assuming the rare case that the number of sites to cover the same area is identical with both the DMR and TETRA):

	DMR	TETRA
IP interconnected repeaters	1xN	10xN
Multicast (multifrequencies)	1xN	10xN
Trunking (Capacity+™)	1,5xN	10xN
Simulcast	4xN	10xN (not simulcast)
Full trunking	??	10xN

Table 1: DMR –TETRA base station indicative cost.

To have the HW cost of the TETRA infrastructure it is necessary to add the node switch cost. The TETRA switches cost may vary a lot from manufacturer to manufacturer, depending to different technology. Moreover, the cost of the TETRA switches may reach about the amount of the base stations cost.

DMR doesn't require any expensive dedicated switch node devices to build a network. The simple IP connection with very low bandwidth (<33 kb/s) between DMR base stations enables to use low cost and general purpose backbone transportation network devices.

New sites and frequency licenses

TETRA in respect to DMR presents a lower RX sensitivity, lower available RF power, UHF band availability only and no simulcast schema. In most practical cases the TETRA system planner has to double the (existing) sites to achieve the same coverage of a DMR system. Some analog existing sites may be powered by solar panel: they must be abandoned migrating in TETRA.

The setup cost of a new site may vary due to many factors: the existence of other services (e.g. broadcasting, TV) in the same place, the availability of the necessary space to put the antennas on the tower, the availability of a primary power supply, the backbone (TCP/IP or Mb/s) transportation network availability, the licenses and authorizations cost, the electromagnetic compatibility with the existing devices, the accessibility, etc.

Experience says that the setup of a new site (adding also antennas, cabling, transportation, and installation) may cost several thousands of dollars.

In addition every site may have a significant fixed cost per year to pay (new) frequency licenses, electricity, space, TCP/IP or Mb/s connections and maintenance visits.

Note also that, due to the narrower band requirement (1/2 of TETRA), DMR may have a lower cost for frequency licenses (it depends by country laws).

It is reasonable keep in account that the change of an analog system to TETRA may require up to double the sites (depend on band and on terrain).

⇒ *With DMR a customer can use the existing frequencies and no other sites are required.*

Migration cost

A customer that is changing his radio system has to consider the costs related to the migration action.

The costs of radio services unavailability for a certain period of time are very difficult to value. However the customer requires few or no radio services "holes" during migration. This need is a harder job to perform with TETRA implementation respect to DMR (see the related previous paragraph).

DMR offers other "real" cost savings compared to TETRA which is unable to use any of the elements of the current mobile radio. Instead with the DMR:

1. The analog existing antennas, RF cable and branching system may be kept (coverage and frequency band will be the same)
2. The analog existing power supply may be kept (the power consumption of DMR is about the same)
3. The existing cabinet may contain the new DMR base station easily (it is very compact, typical a rack 19" x 3TU only)

DMR permits smooth migration from analog to digital system. The automatic dual mode analog/DMR feature permits the coexistence of mixed terminals over the same radio network, so the customer may start up immediately a digital system and substitute gradually old equipments. The investment can be time shared following the customer need. TETRA needs the total substitution of the existing analog terminals with an abrupt "single shot" investment.

Many plants are using low cost UHF (analog) transceivers to connect base station. DMR base station (e.g. Radio Activity and SELEX) can be connected to another DMR transceiver to perform a robust, long distance or non visibility connection. TETRA doesn't allow it and many favorite sites are not reachable by microwave link.

Complexity is a cost. DMR is a very simple system for maintenance people that have analog radio background. It is very similar to the analog one and is easy to understand it. It doesn't require special instrumentation, the analog ones can be used with optimum results. TETRA is a complex system, hard to learn and to maintain, it requires to buy TETRA compliance instrumentation.

CONCLUSION

The TETRA standard was abundantly “gilded” by the vendors to introduce it on the market. The “collateral effects” of its use (costs, complexity, poor radio performance, power supply requirement, coverage capability, ...) were ignored because no valid digital alternatives were available.

The emerging new standard DMR has demonstrate near the same user functionality (digital services, messaging, GPS positioning, crypto, ...) at a fraction of the TETRA cost and without compromises. The mobile terminals of DMR have near the same cost of the TETRA one but the DMR infrastructure has a surprising cost/performances ratio.

The coverage area of a TETRA base station (that is more expensive of a DMR one) may vary from 1/2 to 1/3 of an analog or a DMR base station so TETRA systems may require from 3 to 5 times more sites than DMR. This fact implies that the annual cost of TETRA system (maintenance, frequency licenses, shelter rent, power supply, ...) should be evaluated carefully.

On the contrary of DMR, the intrinsic complexity of TETRA system requires maintenance skill normally unavailable by the technical people of the final customer. The customer is forced “to depend” from supplier of services external to his own organization so the Emergency Operators may meet many difficulties from the involved responsibilities. The TETRA requires an abrupt change of radio system also: the decanted advantages of TETRA really justify the amount of requested sacrifices?

At the end, the TETRA system may be a valid technology for low coverage and high number of users system (industrial sites, airport, ...). If this is not the case of the reader, we would suggest to consider a DMR system before to decide a new radio system investment.